

Einzelfedergerät mit Motiv. Kleine Kunstwerke. Unsere handgeschnitzten Federgeräte sind liebevoll verarbeitet. Auf Wunsch auch ohne Lasur erhältlich. Mit ökologischen Farben gemäss Euronorm 70 behandelt. Fuss und Handgriffe sind in Edelstahl. Feder in silbergrau inklusive Eingrabeanker.



nature



Artikelnummer	FG.080.219
Artikelname	Nashorn
Spielalter	3+
Fallhöhe	60 cm
Platzbedarf	300 x 250 cm
Fallschutz	Minimum Rasen
Fallschutzfläche	7.5 m ²
Gerätemasse	65 x 50 x 78 cm
Schwerstes Teil	45 kg
Anzahl Monteure	1
Montagezeit Total	0.5 h
Ersatzteilgarantie	Lebenslang
Spezielles	Bei Fliessgummiböden ist andere Einbauart nötig. Bitte bei Bestellung angeben.

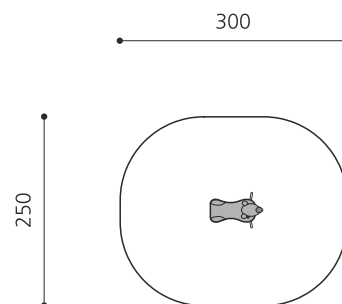

Andere Produkte dieser Gruppe



FG.080.202
Der Vogel



FG.080.203
Heuschrecke

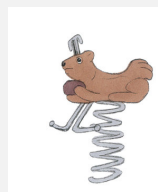

FG.080.204
Eichhörnchen

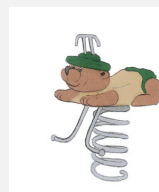

FG.080.205
Der Bello Bär



FG.080.206
Frosch



Direkt zum Produkt





FG.080.208
Dino

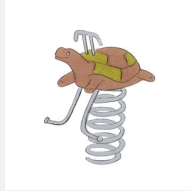

FG.080.209
Schildkröte

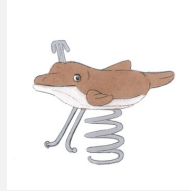

FG.080.211
Delfin



FG.080.213
Robbe

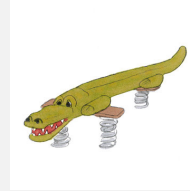

FG.080.215
Krokodil gross



FG.080.216
Schnecke



FG.080.217
Der Hahn

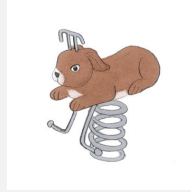

FG.080.221
Häschen

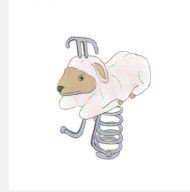

FG.080.222
Schäfchen